



®

NTSC U/C

PlayStation®

ROTYPE

DELTA™



EVERYONE
TM
E
CONTENT RATED BY
ESRB

*For the
first time
in 3D!*

SLUS-00877
8690

agetec™
ASCII GAME ENTERTAINMENT TECHNOLOGY

WARNING: READ BEFORE USING YOUR PlayStation® GAME CONSOLE:

A very small percentage of individuals may experience epileptic seizures when exposed to certain light patterns or flashing lights. Exposure to certain patterns or backgrounds on a television screen or while playing video games, including games played on the PlayStation® game console, may induce an epileptic seizure in these individuals. Certain conditions may induce previously undetected epileptic symptoms even in persons who have no history of prior seizures or epilepsy. If you, or anyone in your family, has an epileptic condition, consult your physician prior to playing. If you experience any of the following symptoms while playing a video game – dizziness, altered vision, eye or muscle twitches, loss of awareness, disorientation, any involuntary movement, or convulsions – IMMEDIATELY discontinue use and consult your physician before resuming play.

WARNING TO OWNERS OF PROJECTION TELEVISIONS:

Do not connect your PlayStation game console to a projection TV without first consulting the user manual for your projection TV, unless it is of the LCD type. Otherwise, it may permanently damage your TV screen.

HANDLING YOUR PlayStation® DISC:

- This compact disc is for use only with the PlayStation® game console.
- Do not bend it, crush it, or submerge it in liquids.
- Do not leave it in direct sunlight or near a radiator or other source of heat.
- Be sure to take an occasional rest break during extended play.
- Keep this compact disc clean. Always hold the disc by the edges and keep it in its protective case when not in use. Clean the disc with a lint-free, soft, dry cloth, wiping in straight lines from center to outer edge. Never use solvents or abrasive cleaners.

R-TYPE

DELTA™

CONTENTS

Story	2
Getting Started.....	4
Operating Instructions.....	5
Modes	6
Registering & Changing Pilot	7
Memory Card Menu	8
User Settings	9
Game Screen	11
Items	12
Warship Functions.....	13
Selecting a Warship.....	16
Stages	22
Enemy Character Introduction	24
War Record.....	26

Thank you for purchasing R-TYPE , software designed for use with the PlayStation® game console. Please read this manual carefully before you play the game, especially those sections that cover operating instructions and safety considerations.

STORY

1. REST

It is the year 2163. The trans-dimensional fighter R9-Arrowhead has returned from its mission to destroy the evil at the center of the Bydo Empire. Badly damaged, it has been rescued by the battle cruiser Croque-Monsieur, and brought back to Earth's orbital space fortress, Aegis.



2. OBSERVATION

Astronomers in Central Asia watched as strange objects began to fall from the sky. As the objects approached closer to the Earth, they shrank in size and disappeared from sensors. The astronomers, assuming the objects to be meteorites, paid them no further attention.



3. CRISIS

Before long, the electronically controlled weapons systems in a number of cities went haywire and several abnormal heat signatures were detected by astronomers. Bydo influence caused control of the orbiting annihilation platform, Moritz-G, to be lost and it was subsequently unleashed upon the Earth.



4. SORTIE

The Moritz-G descended on a city in Asia. Its planet destroying capability has not yet activated, but its self-defense system has thwarted all attempts to approach it. An emergency military operation has been put into effect, and the test fighter R9 Delta has been assigned to the attack force.



GETTING STARTED

Set up your PlayStation game console according to the instructions in its Instruction Manual. Make sure the power is OFF before inserting or removing a compact disc. Insert the R-TYPE Δ disc and close the Disc Cover. Insert a controller and turn the PlayStation game console ON. Follow on-screen instructions to start a game.

NOTE: It is advised that you do not insert or remove peripherals or Memory Cards once the PlayStation game console has been turned ON. Also make sure there are enough free blocks available on your Memory Card before beginning a new game.

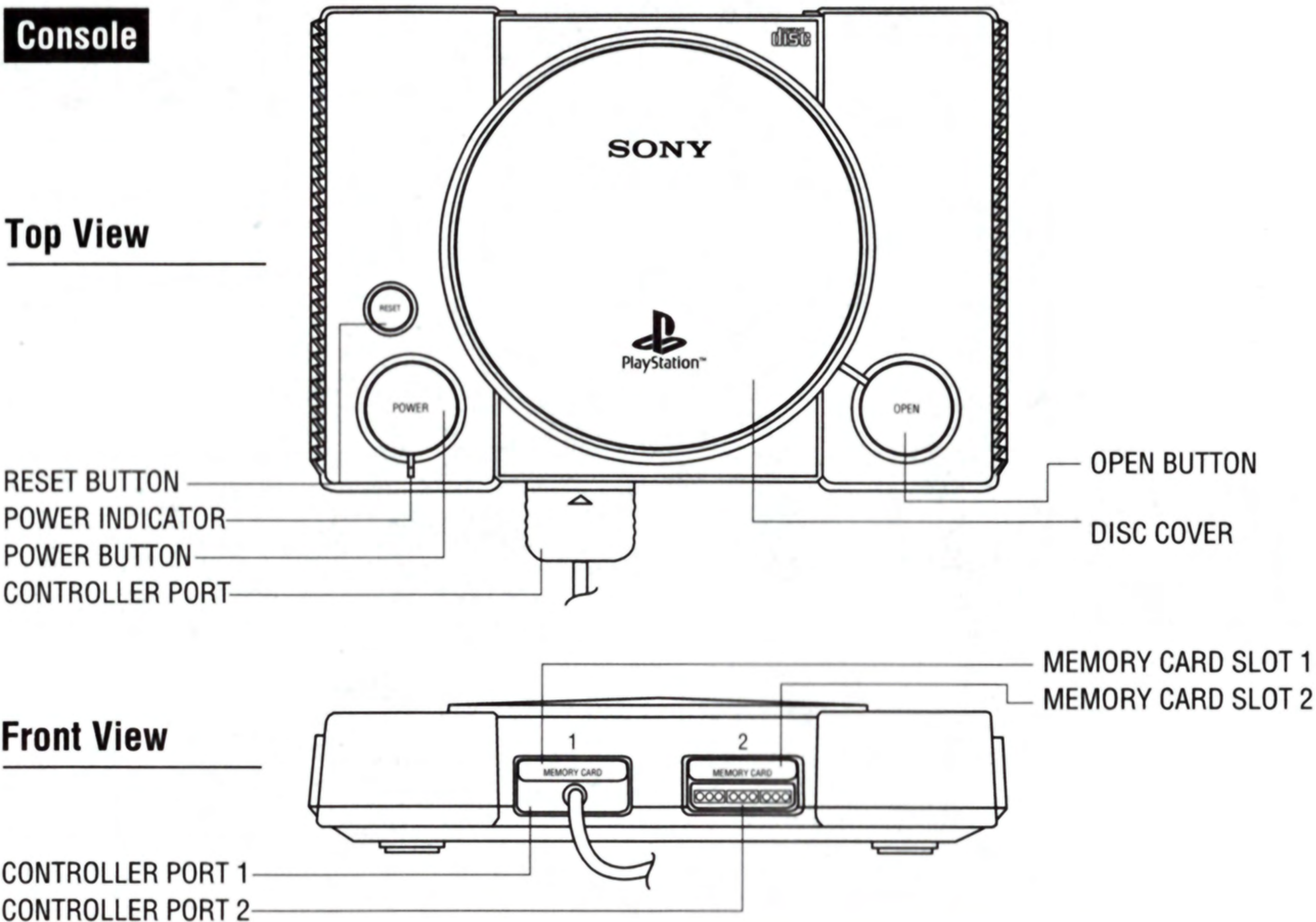

OPERATING INSTRUCTIONS

When using the Dual Shock™ Analog Controller, it will vibrate during the game where appropriate. This function can be turned ON/OFF from the main OPTION menu or the OPTION menu available when the game is paused. Please refer to User Settings on Page 10.

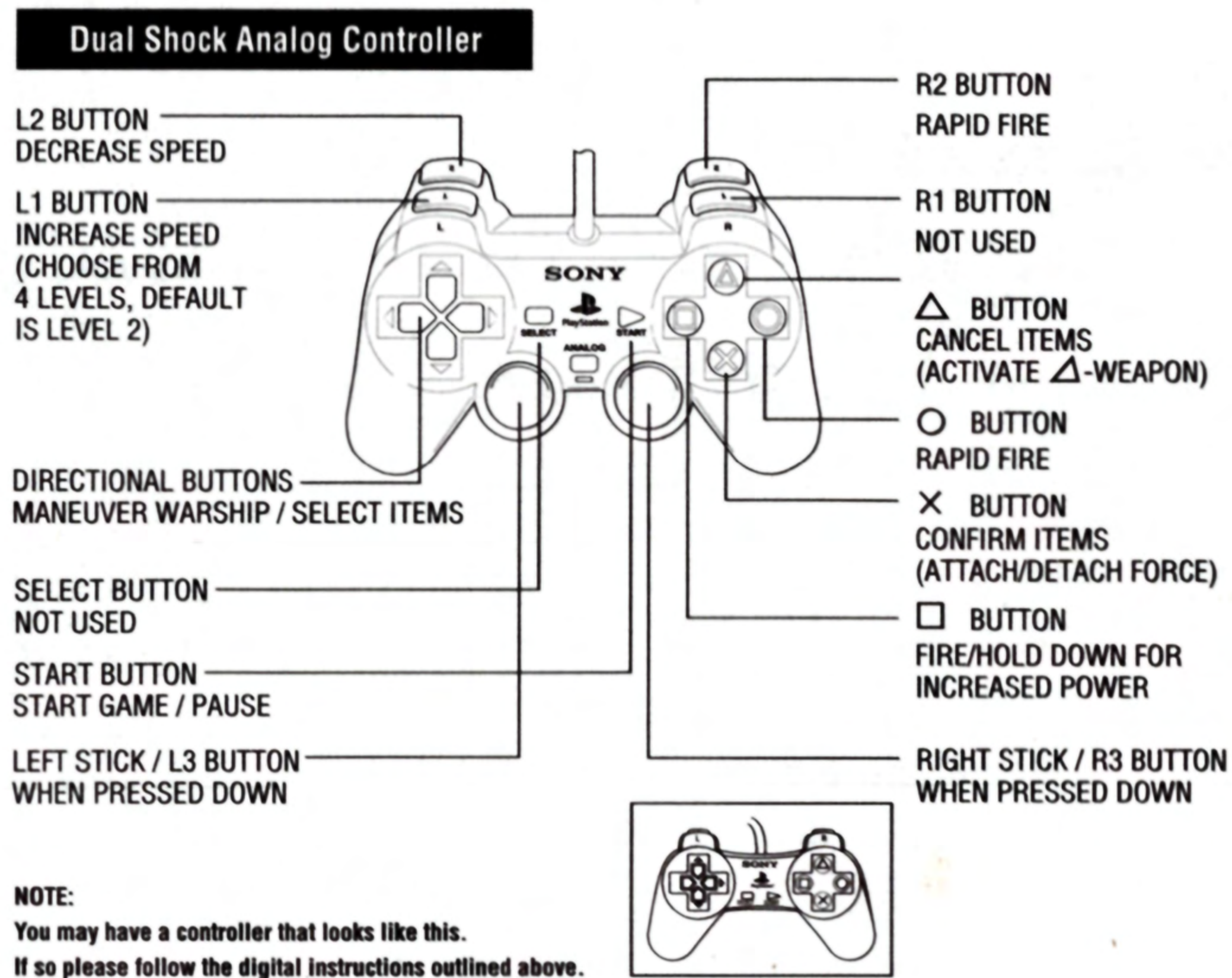

- These are the initial settings. You can change the settings by accessing the OPTION menu.
- This game's vibration feature works whether or not the LED on your Dual Shock™ Analog Controller is ON/OFF.
- To reset to the title screen, press the L1, L2, R1, R2, START, and SELECT Buttons simultaneously.

MODES



At the Title Screen, press the START button to view the main menu selections.

- START GAME:** Starts the game. We recommend selecting the REGISTER PILOT mode and entering your pilot data before starting the game.
- REGISTER PILOT:** Register your pilot name here.
- MEMORY CARD:** Access Memory Card menu options.
- OPTION:** Adjust various user/game settings.
- WAR RECORD:** View various game records.

For more details regarding the sections above please refer to the following pages.

REGISTERING & CHANGING PILOT

NEW GAME

REGISTER PILOT

When playing for the first time, select REGISTER PILOT, and enter your pilot name. Up to three pilots can be registered. View your pilot data from the WAR RECORD menu. In order to save REGISTER PILOT data, a Memory Card with at least one available block is required.



CHANGING PILOT

To change the registered pilot data you want to use, select CHANGE PILOT from the MEMORY CARD menu. Highlight the desired data using the **↑****↓** Directional buttons, and confirm your selection by pressing the **(X)** button.



CONTINUING

When the CONTINUE screen appears, press the **(X)** button to continue. Pressing the **(△)** button will countdown the continue timer, when it reaches zero the game is over. If the Credit count is zero, you cannot continue the game.



MEMORY CARD MENU

ACCESSING MEMORY CARD & MEMORY CARD OPTIONS

- REGISTER PILOT:** Register a new pilot. Select from file numbers 1-3.
- CHANGE PILOT:** Choose registered pilot data that will be used. Select from file numbers 1-3.
- DELETE PILOT:** Delete registered pilot data. Select from file numbers 1-3.
- DATA LOAD:** Load data from a Memory Card.
- DATA SAVE:** Save current settings to a Memory Card.
- AUTO SAVE:** When turned ON, current settings are automatically saved at the end of a game. When turned OFF, data can only be saved using the DATA SAVE option above.
- EXIT:** Return to the main menu screen.

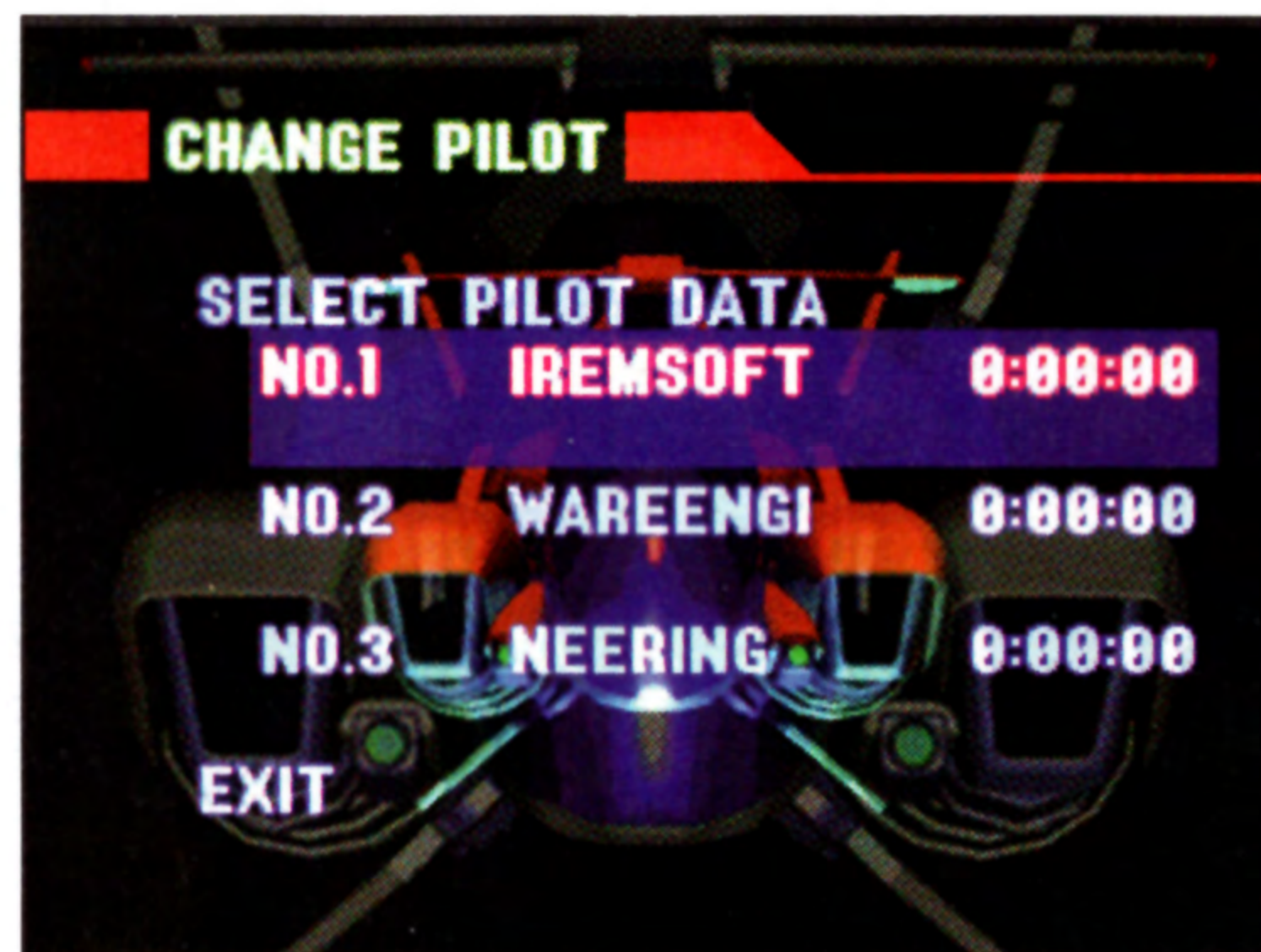

* Insert Memory Card into Memory Card slot 1 only.

USER SETTINGS

OPTION

The OPTION menu allows you to adjust various game settings.

DIFFICULTY: Choose from 3 settings.

EASY
NORMAL
HARD

VIBRATION: For use with the Dual Shock™ Analog Controller only.

ON-Turn vibration feature on
OFF-Turn vibration feature off

KEY CONFIGURATION: Change default button settings

NORMAL FIRE: Standard firing method, hold for increased firepower.

RAPID FIRE: Press and hold for rapid fire.

FORCE: Attach/Detach Force

△-WEAPON: Fire △-Weapon

SPEED UP: Increase Warship's speed

SPEED DOWN: Decrease Warship's speed

DEFAULT: Reset all buttons to their default settings.

SOUND: Listen to in-game sounds/music. Adjust SE & BGM balance. Select between Stereo and Monaural sound settings.

EXIT: Return to the main menu screen.



PAUSE MENU

Press the START button during gameplay to pause the game. Doing so also makes the following options available.

RETURN: Exit PAUSE screen and return to game.

OPTION:

PREVIOUS MENU: Go back to the original PAUSE menu.

ADJUSTMENT: Adjust screen position

VIBRATION: For use with the Dual Shock™ Analog Controller only.

ON: Turn vibration feature on

OFF: Turn vibration feature off

COCKPIT: Select between three different cockpit configurations.

OFF: No cockpit display

TYPE 1: Graphically displays Δ -weapon energy on the bottom left hand side of the screen.

TYPE 2: Displays Δ -weapon energy as a percentage on the bottom left hand side of the screen.

KEY CONFIG: Change default button settings. See pg. 9 for details.

QUIT GAME: Quit current game and return to title screen. A confirmation message will be displayed.



GAME SCREEN

Player's Warship



Warships
Remaining

Beam
Gauge

Score

△ - Weapon
Energy Gauge

ITEMS

POW ARMOR: Destroy these robots to release the items below, which you can then collect.



LASER CRYSTALS: Upgrade your FORCE and fire a variety of lasers.

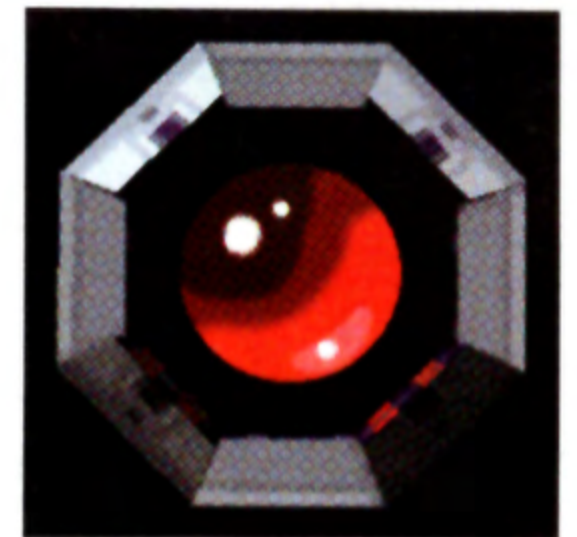

BITS: A maximum of two BITS can be collected. The first will attach to the top of your Warship, the second will attach to the bottom.



MISSILES: Enables you to fire missiles.



WARSHIP FUNCTIONS

CHANGING SPEED

Your Warship has four levels of speed, the default when you begin is level two.

While playing, pressing certain buttons will allow you to alter your Warship's speed.

* These button functions can be changed using KEY CONFIG in the OPTIONS menu

Controller

Front View

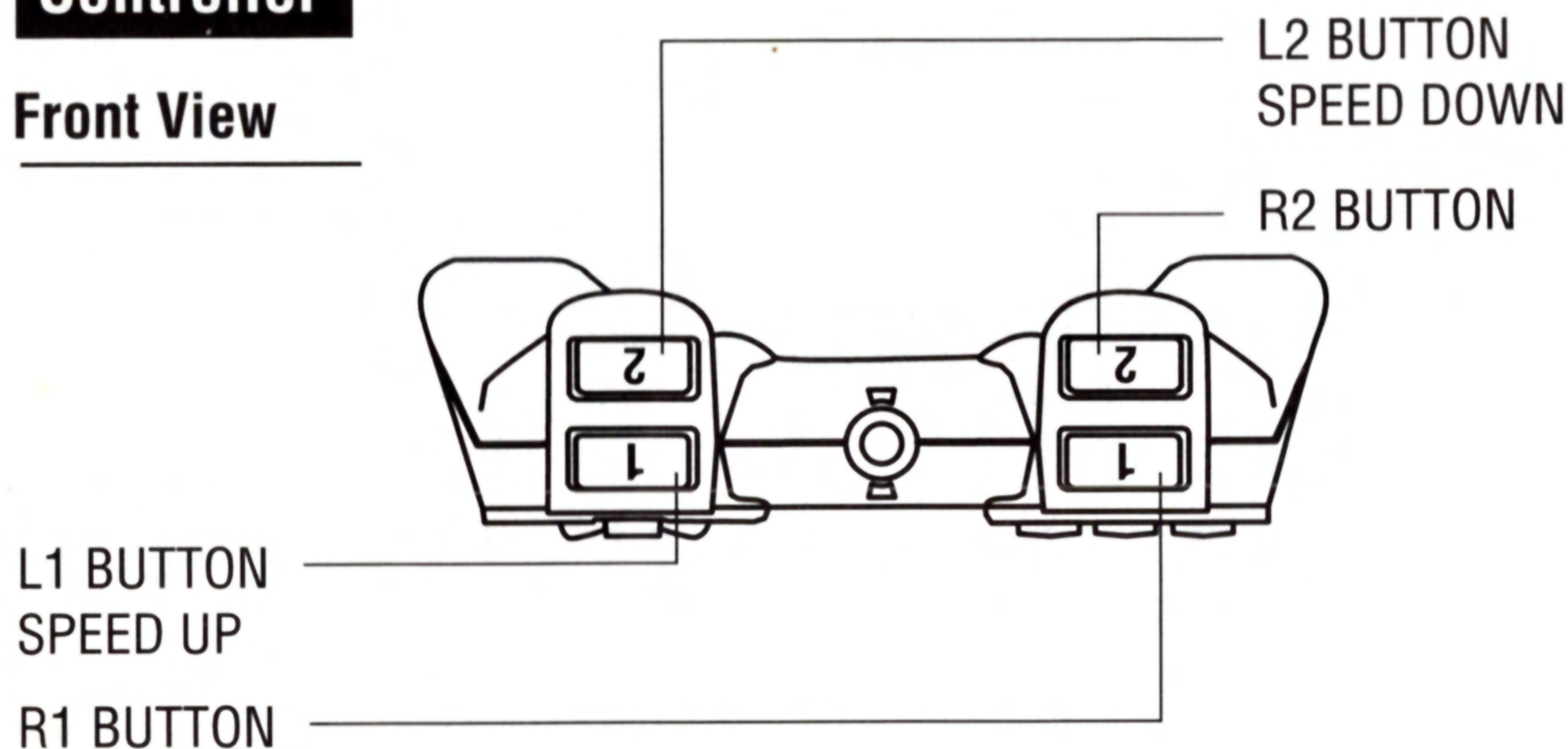

FORCE

When you pick up LASER CRYSTALS, the FORCE module will appear on-screen. This module can cause damage to enemies, and absorb enemy attacks - the FORCE module, unlike your craft, is indestructible. Use the  button to attach/detach the FORCE module to/from your Warship. The module can be attached to either the front or back of your Warship enabling different modes of fire.

Each Warship can collect three different types of FORCE modules. These are differentiated by the Blue, Red, and Yellow LASER CRYSTALS. Choosing a FORCE module best suited to a particular situation is one of the most effective tactics for defeating the enemy. The FORCE module can also be upgraded, in three stages, by collecting more LASER CRYSTALS of the same color.

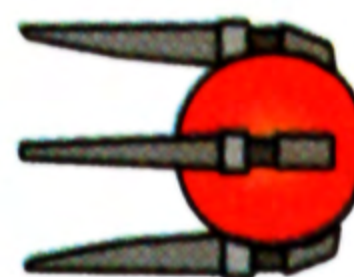
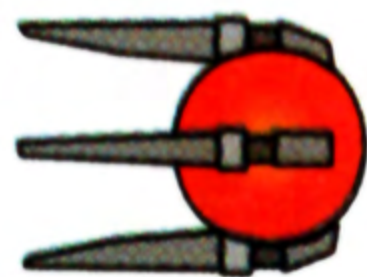

FORCE combination firing backwards.



FORCE combination firing forwards.







WAVE CANNON

Press and hold the  button to charge the Wave Cannon's energy. The Wave Cannon's energy level is indicated by the beam gauge at the bottom of the screen. The longer the  button is held down, the more powerful the energy release will be. For an enhanced energy release press and hold the  button until the beam gauge flashes red, then let go of the button.



-WEAPON

The -Weapon's energy level rises with the amount of enemies you defeat and the amount of enemy fire absorbed by your FORCE module. The -Weapon's energy gauge is displayed at the bottom left hand side of the screen.

Charging the energy level to its maximum will automatically upgrade the FORCE module and allow the -Weapon to be activated. Press the  button to release the stored energy, causing serious damage to all on-screen enemies.

* The -Weapon cannot begin charging until you have acquired a FORCE module.

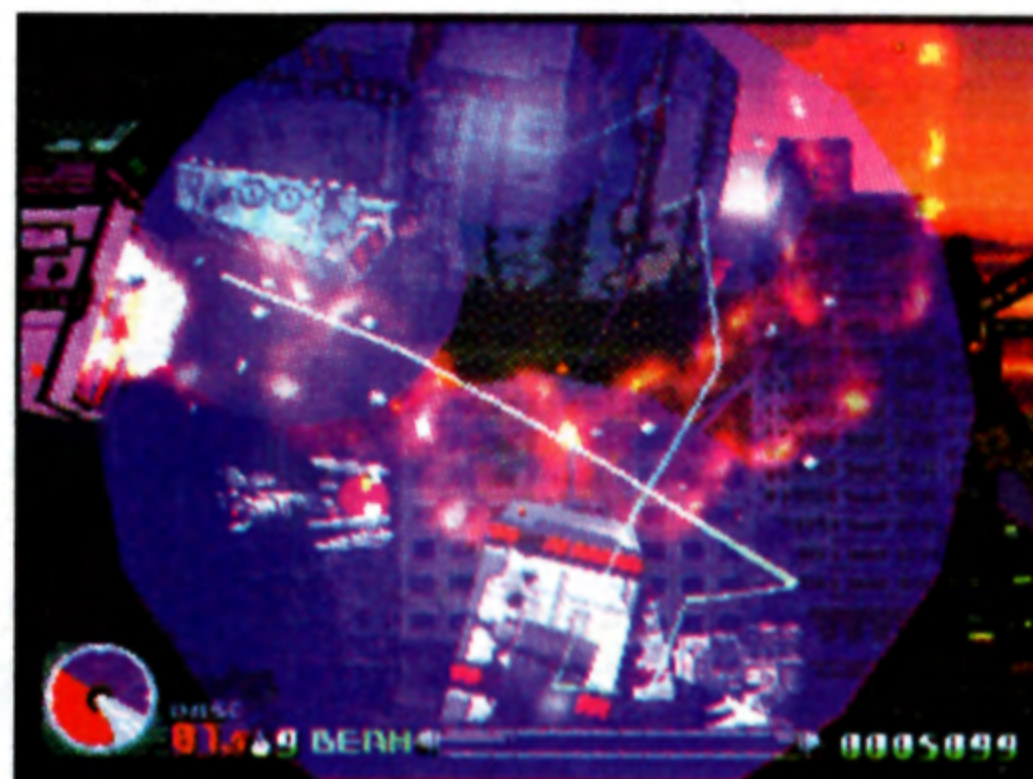

SELECTING A WARSHIP

Three different types of R-Type Warships are available when you begin a game. Press the **← →** Directional buttons to cycle through the available craft at the launch hangar, and use the **⊗** button to confirm your selection.



The R9a Delta comes equipped with a diffusion wave cannon, which concentrates and then disperses its energy using a special catalyzer. It is also equipped with the same wave cannon found on the R9 mass-production models.

WAVE CANNON

Releases charged energy at enemies directly in front of the Warship with devastating force.



NUCLEAR CATASTROPHE (△-Weapon)

Creates nuclear fusion using the molecules surrounding the ship, causing extreme damage to the enemy.

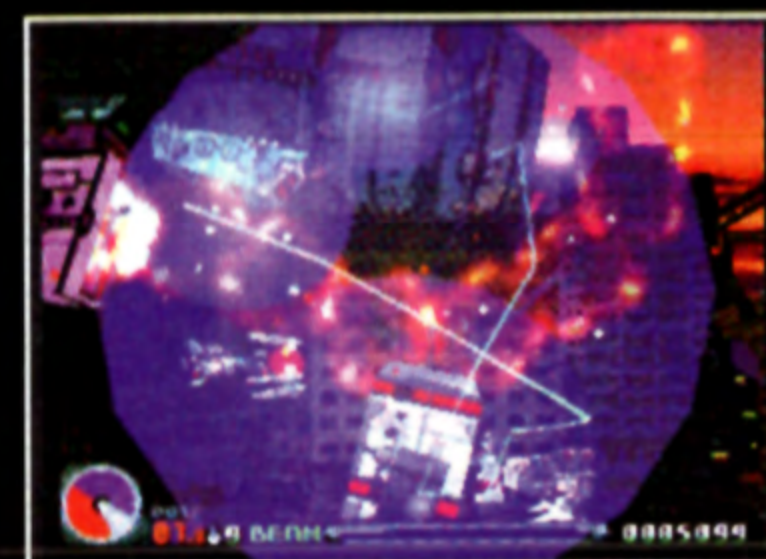

HOMING MISSILES

Two simultaneously launched missiles that home in on the enemy.



STANDARD FORCE

Highly reliable module, due to the extensive combat data gathered from its use in previous missions. When detached from the Warship it can fire lasers in as many as four directions.



AIR-TO-AIR LASER (Red)

Powerful laser fired in the direction that the FORCE module is attached.



REFLECTIVE LASER (Blue)

Fires in three directions simultaneously. Reflects off of geographical formations.



AIR-TO-GROUND LASER (Yellow)

Fires both above and below the Warship, and travels along the edges of geographical formations.



TYPE 2: Rx

The Rx model is a unique prototype developed by the Air Force in collaboration with the aircraft manufacturer, McGwire Co. Ltd. It's surface is finished with a mirror coating which acts as a countermeasure against optical weapons.



WAVE CANNON

Generates energy within the enemy causing fatal damage.

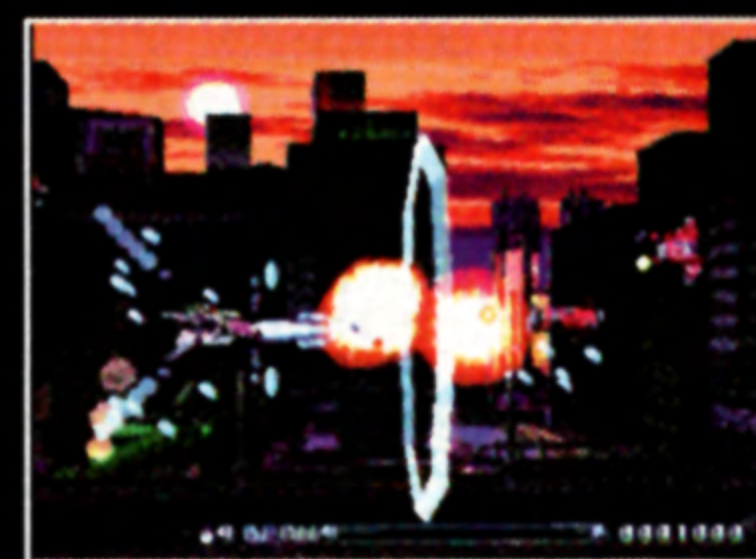

NEGATIVE CORRIDOR (△-Weapon)

Generates a distortion in time and space causing serious damage to many enemies.



CHAIN REACTION MISSILE

Capsulated missile, that detonates upon contact with the enemy.



TENTACLE FORCE

This module's laser control accuracy has been enhanced with bio-neural circuitry. When it is detached from the Warship, it automatically searches for targets, firing only when you do.



STING RAY (Red)

Can be concentrated or dispersed.



HOUND RAY (Blue)

Locks onto powerful enemies.



SNAIL RAY (Yellow)

Bends like a tentacle.



TYPE 3: R13

Built by the military manufacturer Warelic Co., Ltd. and different in structure from the conventional R-series models. Equipped with a lightning wave cannon, which adds a homing feature to the conventional wave cannon. The lightning wave cannon senses the target and fires on it accurately.



LIGHTNING WAVE CANNON

Seeks out the enemy and destroys it.



HYSTERIC DAWN (△-Weapon)

Tears open a dimensional rift, which blows the enemy out of space and time.

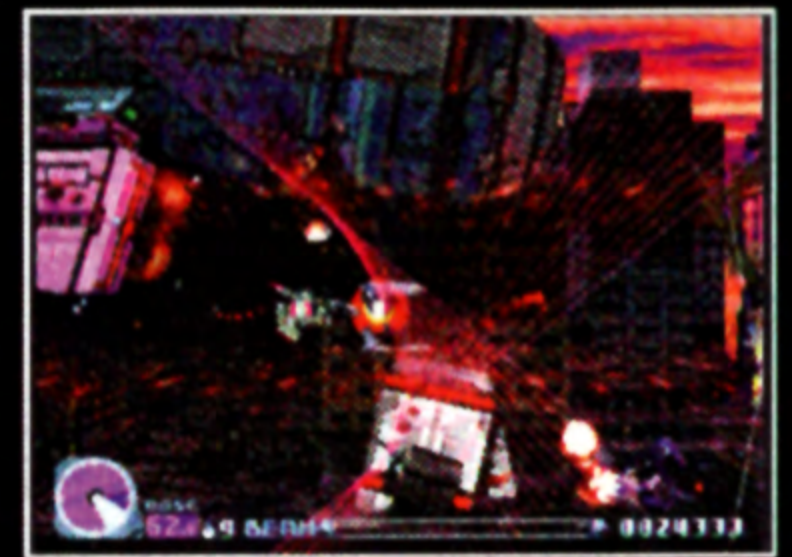

PHOTON MISSILE

An accelerating missile, fired horizontally.



ANCHOR FORCE

The claw-shaped rods bite into objects they come in contact with as a means of destroying that object. It is linked to the Warship by a flexible beam of energy which is useful in damaging enemies and absorbing their fire.

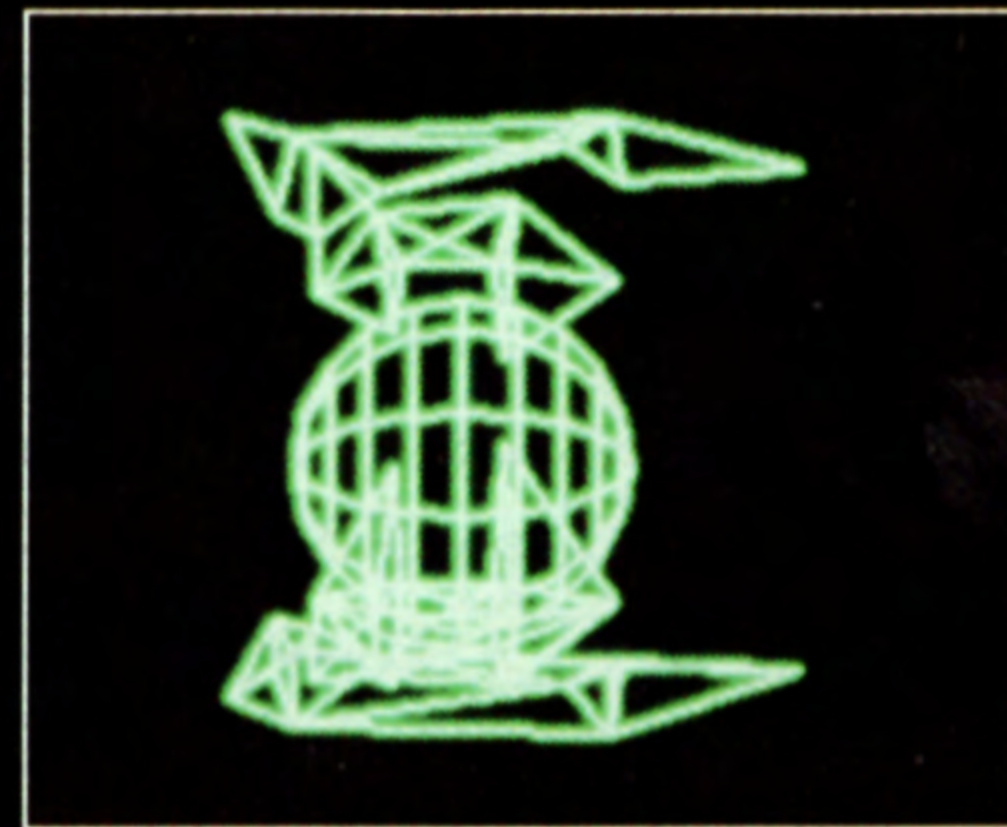

SHADE α (Red)

A powerful laser that changes its power and attack area depending on the Warship's movements.



SEARCH β (Blue)

Able to bend by 45° in order to target an enemy.



TERMINATE γ (Yellow)

Accurately fires on all enemies around the FORCE module.



STAGES

STAGE 1: LETHAL WEAPON

The annihilation platform, Moritz-G, is out of control and about to destroy all the cities on Earth. In urban areas, the Warships struggle desperately with Mecha-Bydo intruders. Defend the Earth at all costs!



STAGE 2: DEFORMATION

The reactor that once generated vast amounts of energy for various scientific and military facilities was submerged during a Bydo attack. Deformed aquatic creatures now inhabit this dark world.



STAGE 3: GIGANTIC ATTACK

The super-carriers developed by scientists, and intended for use in the transportation of space shuttles, have been taken over by the Bydo and now threaten human existence. Unfortunately their makers designed them so well that they are nearly indestructible.



STAGE 4: INVASION

A space fortress, altered by the Bydo, into a labyrinth of evil. Can you save the fortress, thereby protecting the Earth's last line of defense?

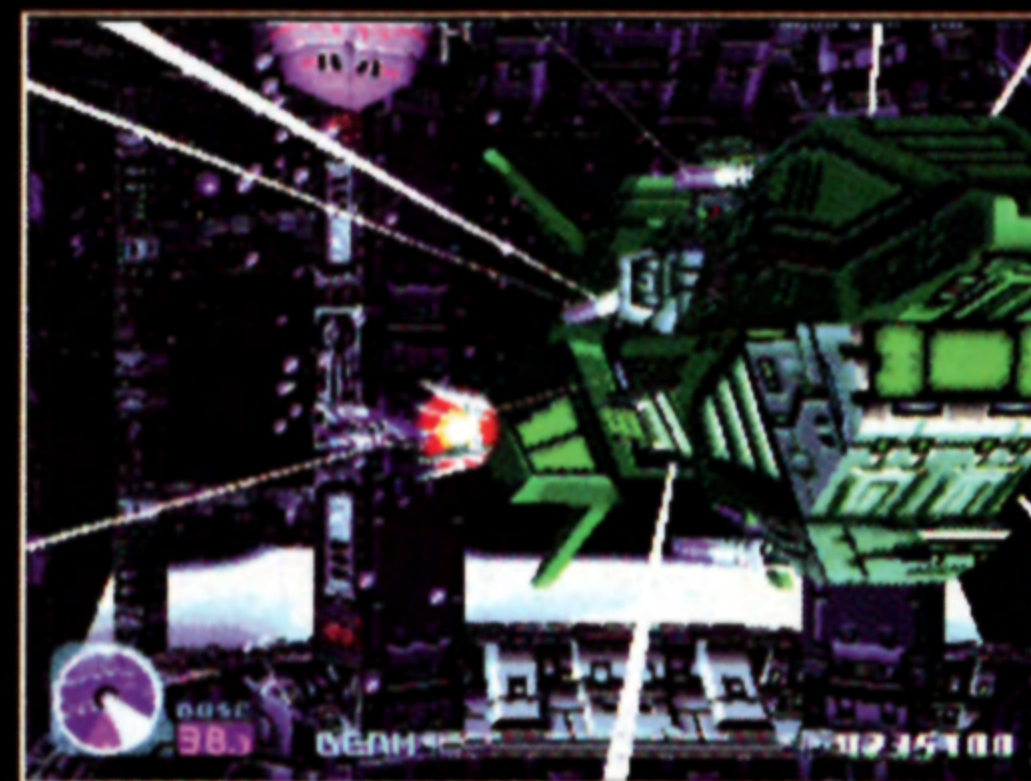

STAGE 5: EVIL

After their successful combat at the space fortress, your fellow pilots drifted off course on their return journey home. They were caught in a strange dimensional rift and their spirits were altered by the Bydo. They've returned and have you in their sights!

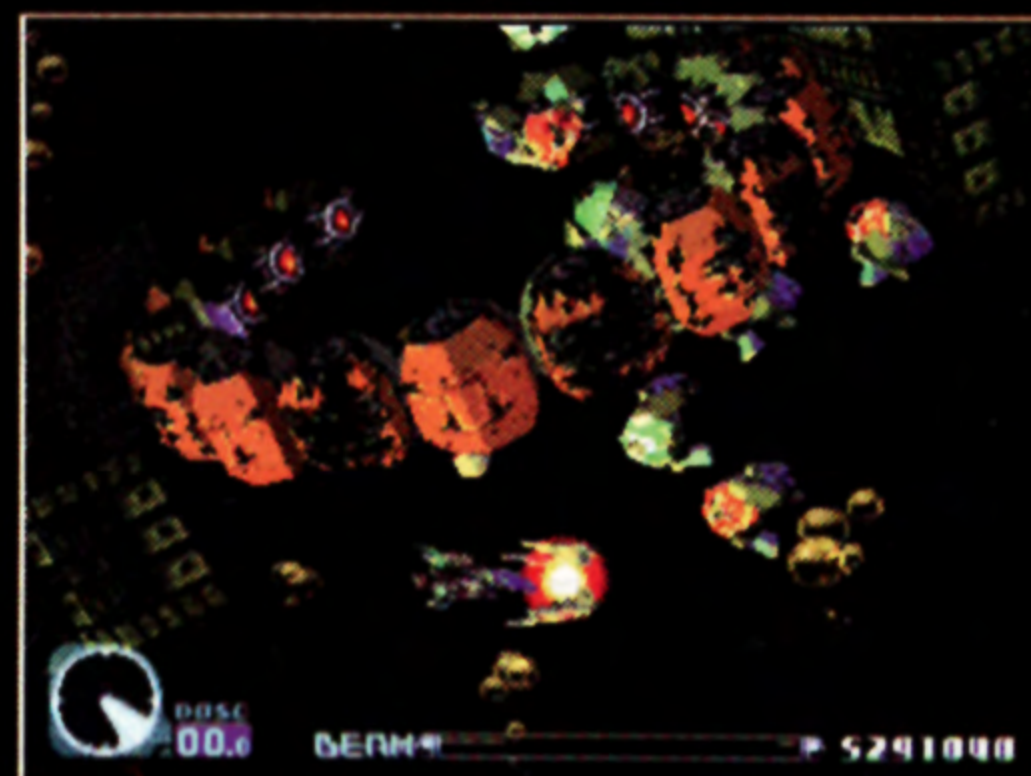

STAGE 6: AWAKENING

The R-series fighter-development project has lost all communications with the outside. The pilots are fighting to expel the parasitic Bydo, and are beginning to get the upper hand. The pride of the R-series fighter pilots is about to awaken.

STAGE 7: LIFE

Space and time are distorted as the entrance to a different dimension suddenly appears in the Earth's orbit. Escaping the evil energy forms, the pilots and their Warships set their targets on the last enemy...Bydo Core. Let the final dance begin!

ENEMY CHARACTER INTRODUCTION



EVE

A new creature created by the Bydo using the cells of living organisms from Earth. They are believed to have the ability to reproduce.



MORITZ-G

An extremely powerful weapons platform with vast destruction capability. Due to its terrifying potential it has been kept concealed by the humans. Unfortunately it was infected by the Bydo and is now running rampant.



CONTRITE

A gigantic asphalt crusher, originally used by humans for city renovations. Since being infected by the Bydo it has become a large-scale slaughtering machine.



GOUGHER

A dimension travelling organic weapon, evolved from a living Bydo cell. Its internal organs and bone structure protrude through its skin and it will attack any moving object.



U-LAUNCH MISSILE POD

An interceptor robot which if attacked will automatically retaliate. Its attack consists of missile launchers located on both shoulders which fire two homing missiles each.

CYST

A huge living organism. It's cave dwelling was destroyed, forcing it to wander through different dimensions.



GAINES

A defensive robot unit equipped with a large, powerful cannon.

WAR RECORD

YOUR RECORD

View overall game progress.

- TIMES PLAYED
- HOURS PLAYED
- DESTRUCTION RATE
- WAVE CANNON ENERGY USED
- TIMES DELTA WEAPON USED
- AVG SCORE PER SHIP
- HIGH SCORE
- SCORE* STAGES 1-7

*This screen displays the high scores for each of the seven stages, type of Warship used, and difficulty setting.

Select a stage from the BEST SCORE menu and press the (X) button, a password will be displayed. Send your password via email to the email address listed below. The best R-Type Δ scores will be displayed on Agetec's homepage at the following address (<http://www.agetec.com>).

Email address: gamemaster@agetec.com

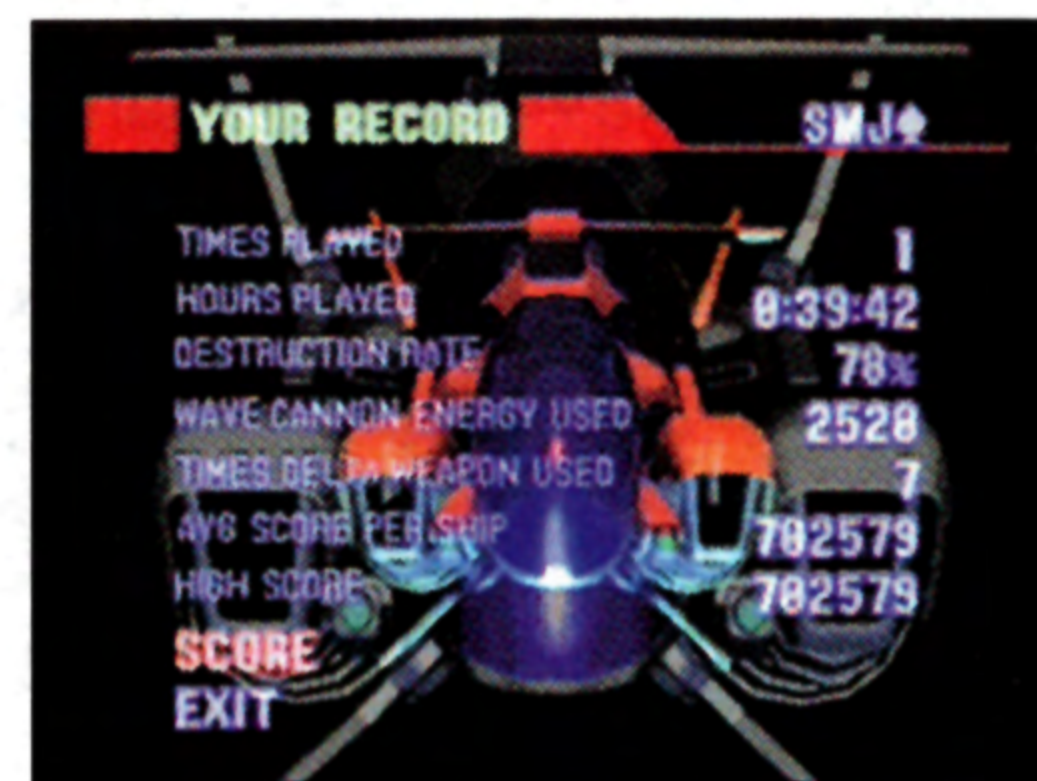

NOTES

As your piloting ability improves, your journey towards the rank of Ace Pilot is recorded here.



GALLERY

Choose from a variety of graphic designs to be used as background images for the menu screens. The number of designs you are able to select from increases as you achieve certain conditions during the missions.



NOTES

Agetec, Inc. Limited Warranty

Agetec, Inc. warrants to the original purchaser of this Agetec, Inc. product that the medium on which this software program is recorded is free from defects in materials and workmanship for a period of ninety (90) days from the date of purchase. Agetec, Inc. agrees for a period of ninety (90) days to either repair or replace, at its option, the Agetec, Inc. product. You must call (650) 780-0166 to receive instructions to obtain repair/replacement services.

This warranty shall not be applicable and shall be void if the defect in the Agetec, Inc. product has arisen through abuse, unreasonable use, mistreatment or neglect. THIS WARRANTY IS IN LIEU OF ALL OTHER WARRANTIES AND NO OTHER REPRESENTATIONS OR CLAIMS OF ANY NATURE SHALL BE BINDING ON OR OBLIGATE AGETEC, INC. ANY IMPLIED WARRANTIES APPLICABLE TO THIS SOFTWARE PRODUCT, INCLUDING WARRANTIES OF MERCHANTABILITY AND FITNESS FOR A PARTICULAR PURPOSE, ARE LIMITED TO THE NINETY (90) DAY PERIOD DESCRIBED ABOVE. IN NO EVENT WILL AGETEC, INC. BE LIABLE FOR INCIDENTAL OR CONSEQUENTIAL DAMAGES RESULTING FROM POSSESSION, USE, OR MALFUNCTION OF THE AGETEC, INC. SOFTWARE PRODUCT.

Some states do not allow limitations as to how long an implied warranty lasts and/or exclusions or limitations of consequential damages, so the above limitations and/or exclusions of liability may not apply to you. This warranty gives you specific legal rights, and you may also have other rights which vary from state to state.

Repair/Service After Expiration of Warranty – If your game disc requires repair after expiration of the 90-day Limited Warranty Period, you may contact the Consumer Service Department at the number listed below. You will be advised of the estimated cost of repair and the shipping instructions.

Agetec, Inc. Customer Service Department/Technical Support Line (650) 780-0166 – Call this number for help in installing or operating our products or for general product questions. Representatives are available Monday-Friday, 9am-4pm Pacific Time. There is no charge for this service.

Hint Line – Game hints are available within the US at 1-900-288-2724. The cost is \$0.95 per minute, and automated support is available 24 hours per day, 7 days a week. This hint line supports games produced by Agetec, Inc. No hints will be given on our Customer Service Line. Long distance charges are included in the above rates. Callers under 18 years of age must obtain permission from a parent or guardian before calling. A touch-tone phone is required.

Agetec, Inc. Online at <http://www.agetec.com> – Our news is always cool! Visit our website and find out what's happening at Agetec, Inc. – new titles, new products, and fresh tidbits about the new gaming world!

Ready for more R-TYPE action?

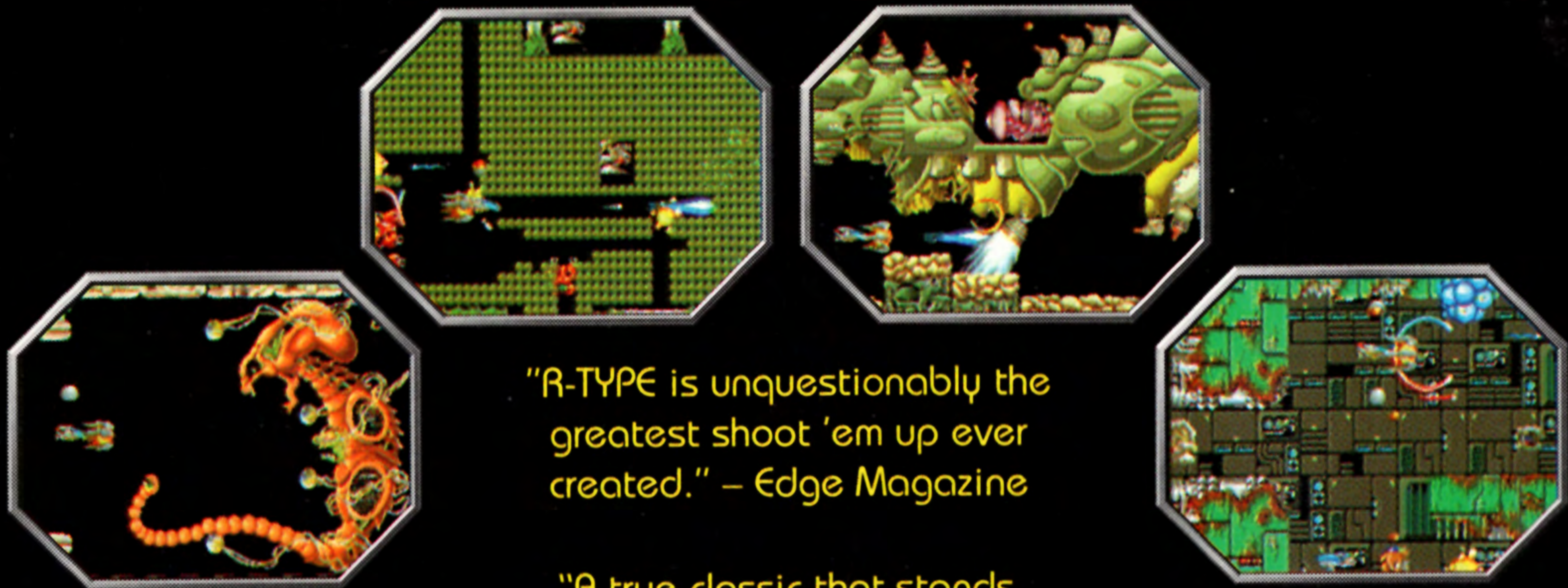

"R-TYPE is unquestionably the greatest shoot 'em up ever created." – Edge Magazine

"A true classic that stands the test of time" – PSM



Now you can experience all the excitement of R-Type and R-Type II in one great package. R-Types takes you back to where the legend began with pixel perfect translations of the two arcade classics that started it all. Also included is bonus video footage and a complete R-Type history and reference library.

Available now!

Agetec, Inc. 900 Veterans Boulevard, Suite 600, Redwood City, CA 94063
IREM SOFTWARE ENGINEERING, INC. All rights reserved. R-TYPES, R-TYPE Delta, the R-TYPES logo and the R-TYPE Delta logo are trademarks of IREM SOFTWARE ENGINEERING, INC. Published by Agetec, Inc. All other brand and product names are trademarks or registered trademarks of their respective owners.

Licensed by Sony Computer Entertainment America for use with the PlayStation game console. PlayStation and the PlayStation logos are registered trademarks of Sony Computer Entertainment Inc. The ratings icon is a trademark of the Interactive Digital Software Association. Manufactured and printed in the U.S.A. THIS SOFTWARE IS COMPATIBLE WITH PLAYSTATION GAME CONSOLES WITH THE NTSC U/C DESIGNATION. U.S. AND FOREIGN PATENTS PENDING.

irem

agetec
ASCII GAME ENTERTAINMENT TECHNOLOGY

